

1KS místnost D204090  
1KS místnost D204580

2KS

STOLEK DOPLŇKOVÝ

01

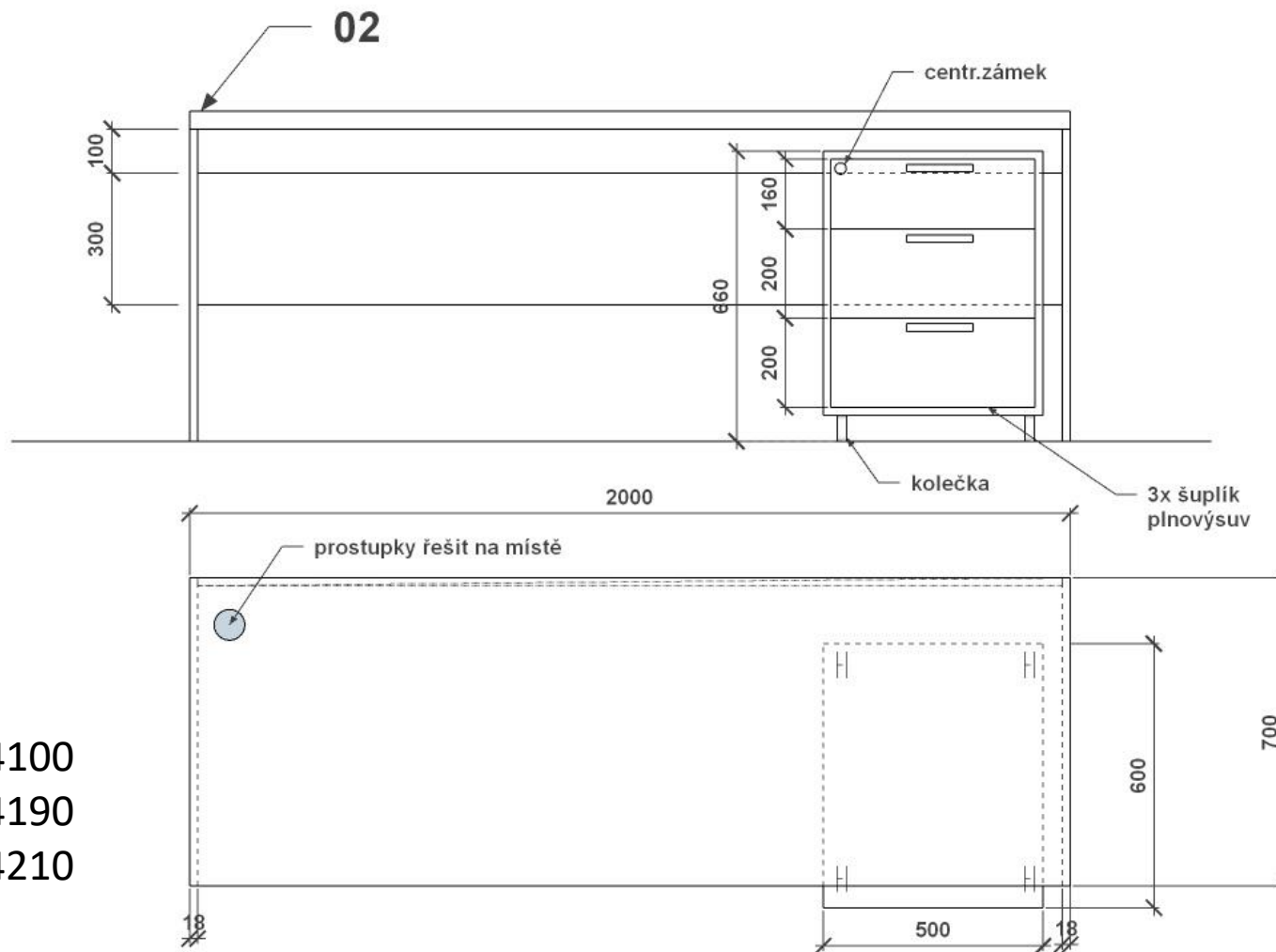

1KS místnost D204100  
 1KS místnost D204190  
 2KS místnost D204210

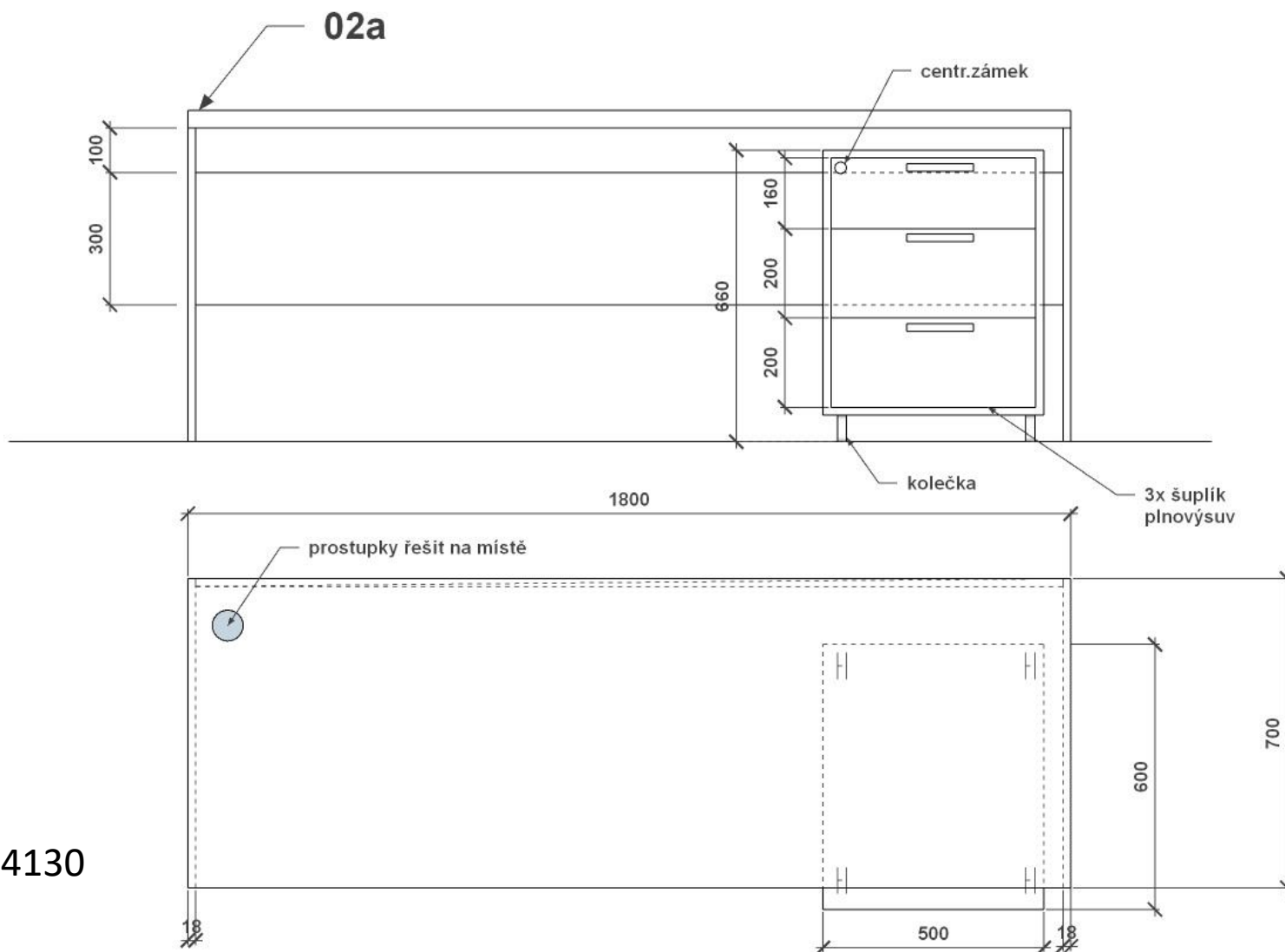

1KS místnost D204130

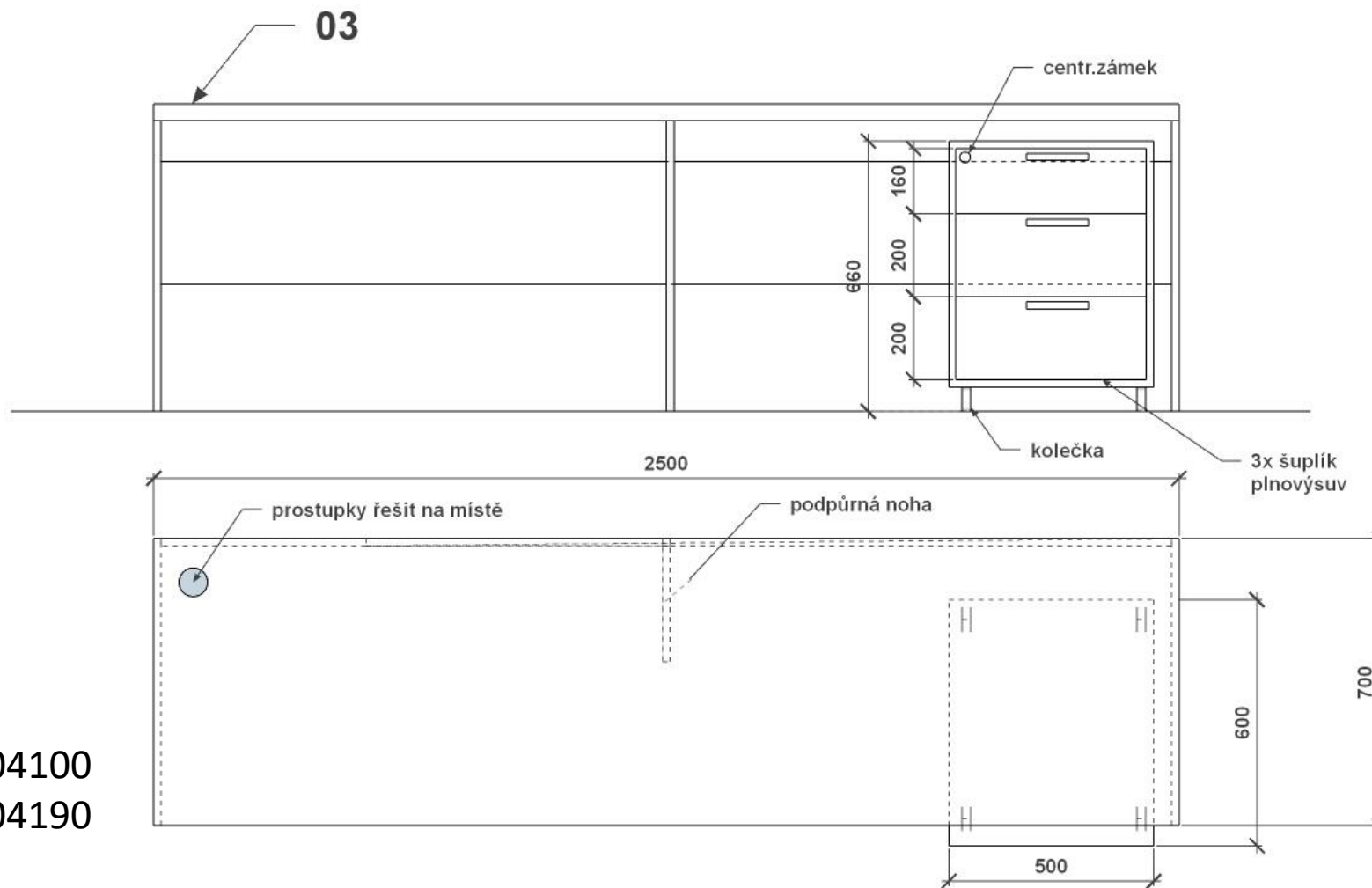

1KS místnost D204100  
1KS místnost D204190

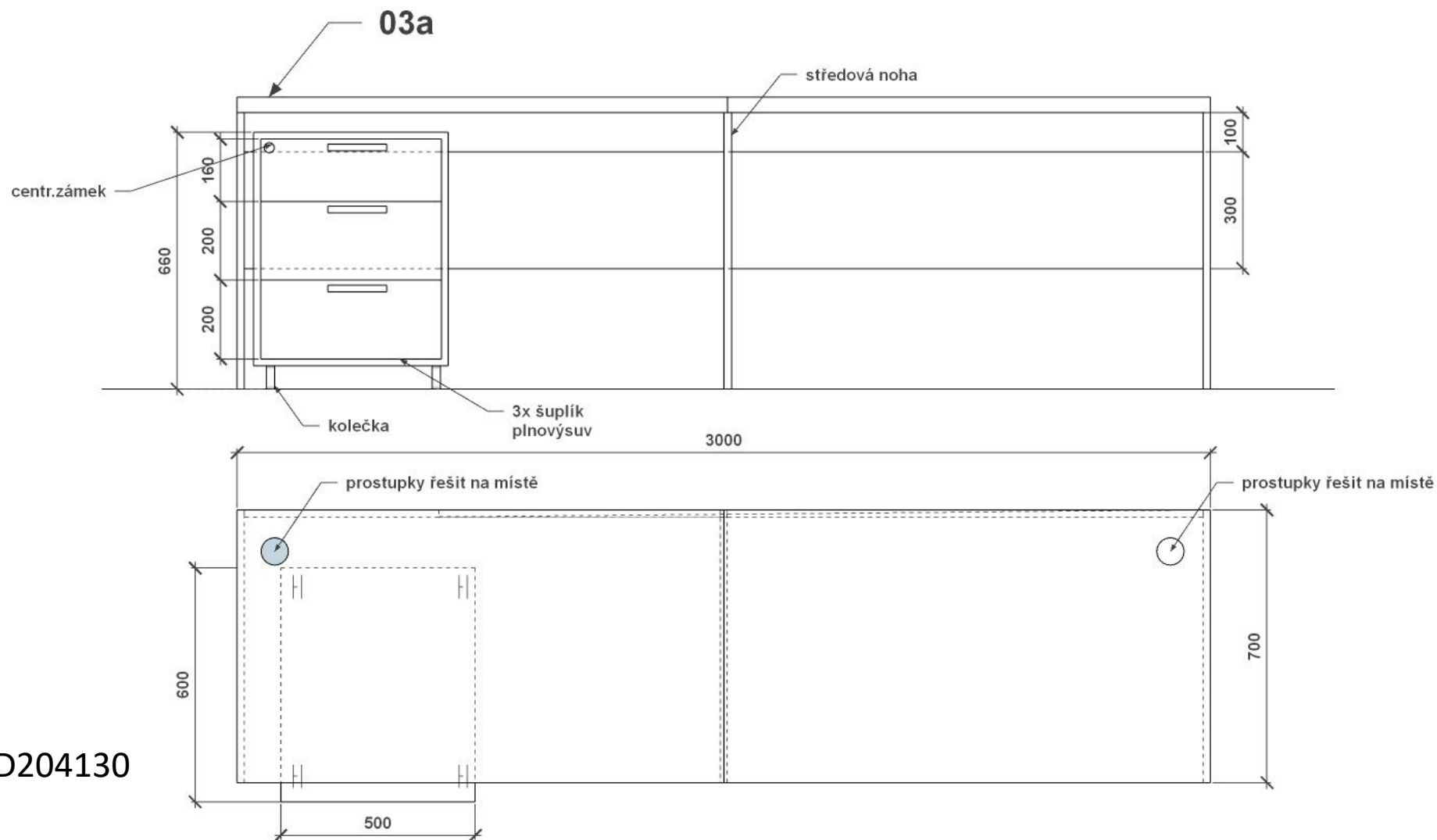

1KS místnost D204130

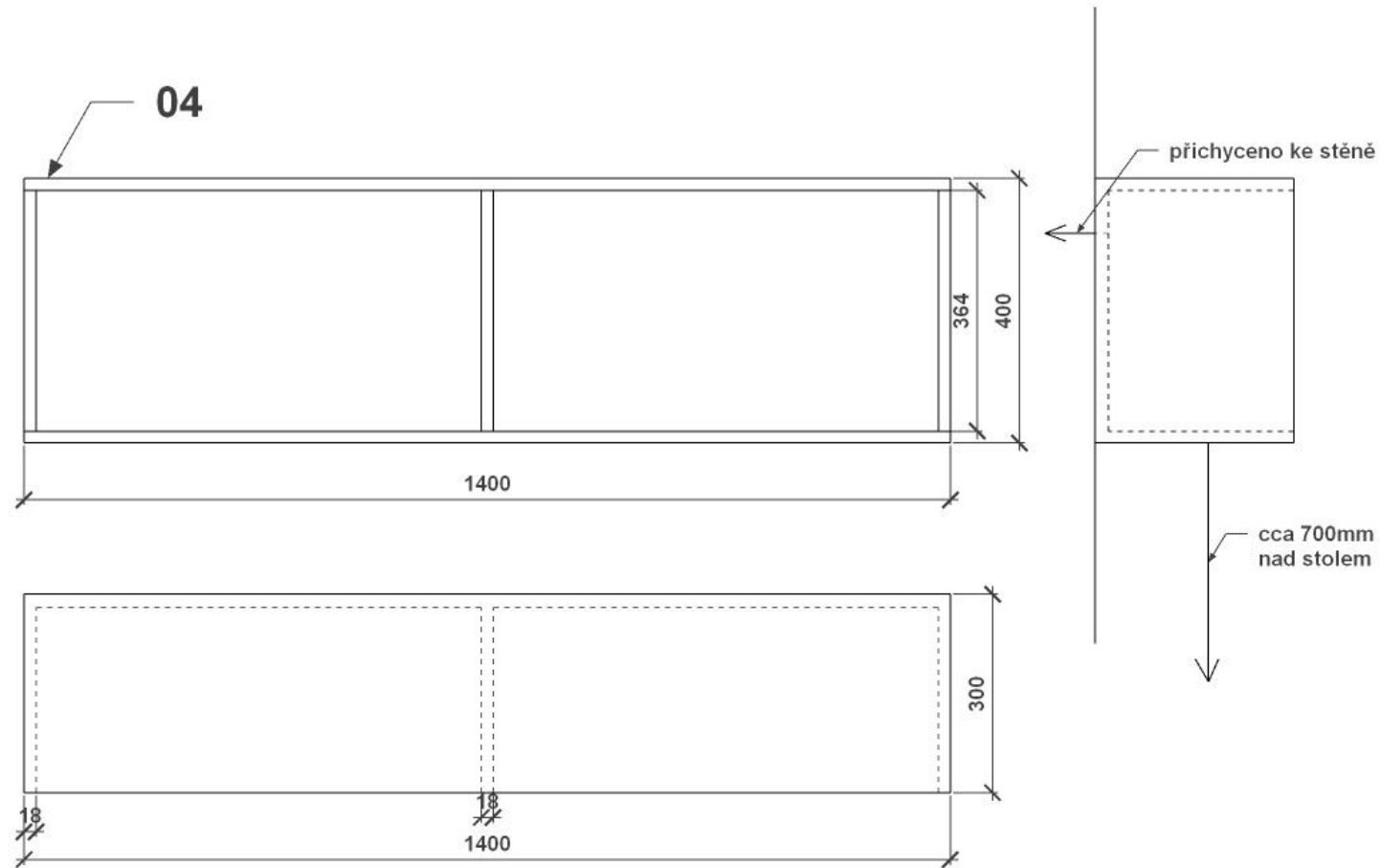

2KS místnost D204100  
2KS místnost D204190

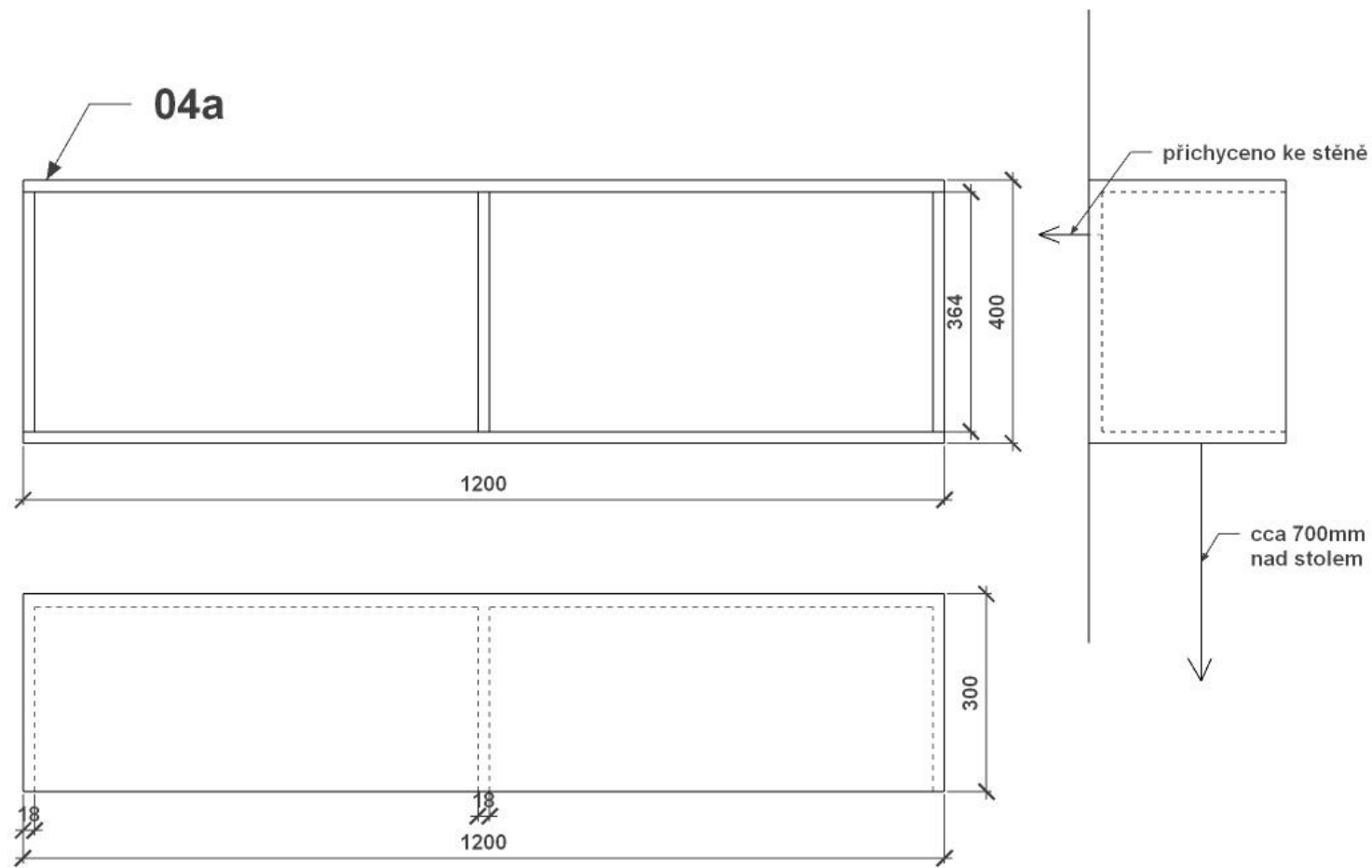

3KS místnost D204130  
2KS místnost D204210



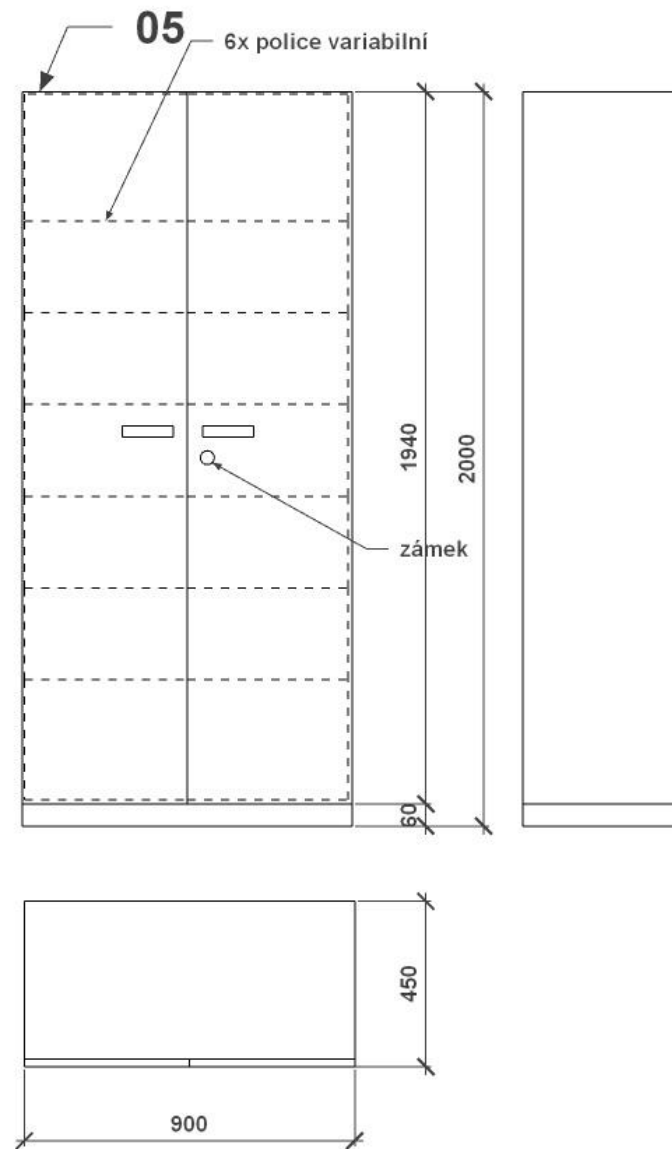

2KS místnost D204100 – 6 polic na léky  
 2KS místnost D204190 – 5 polic šanony  
 2KS místnost D204210 – 5 polic šanony

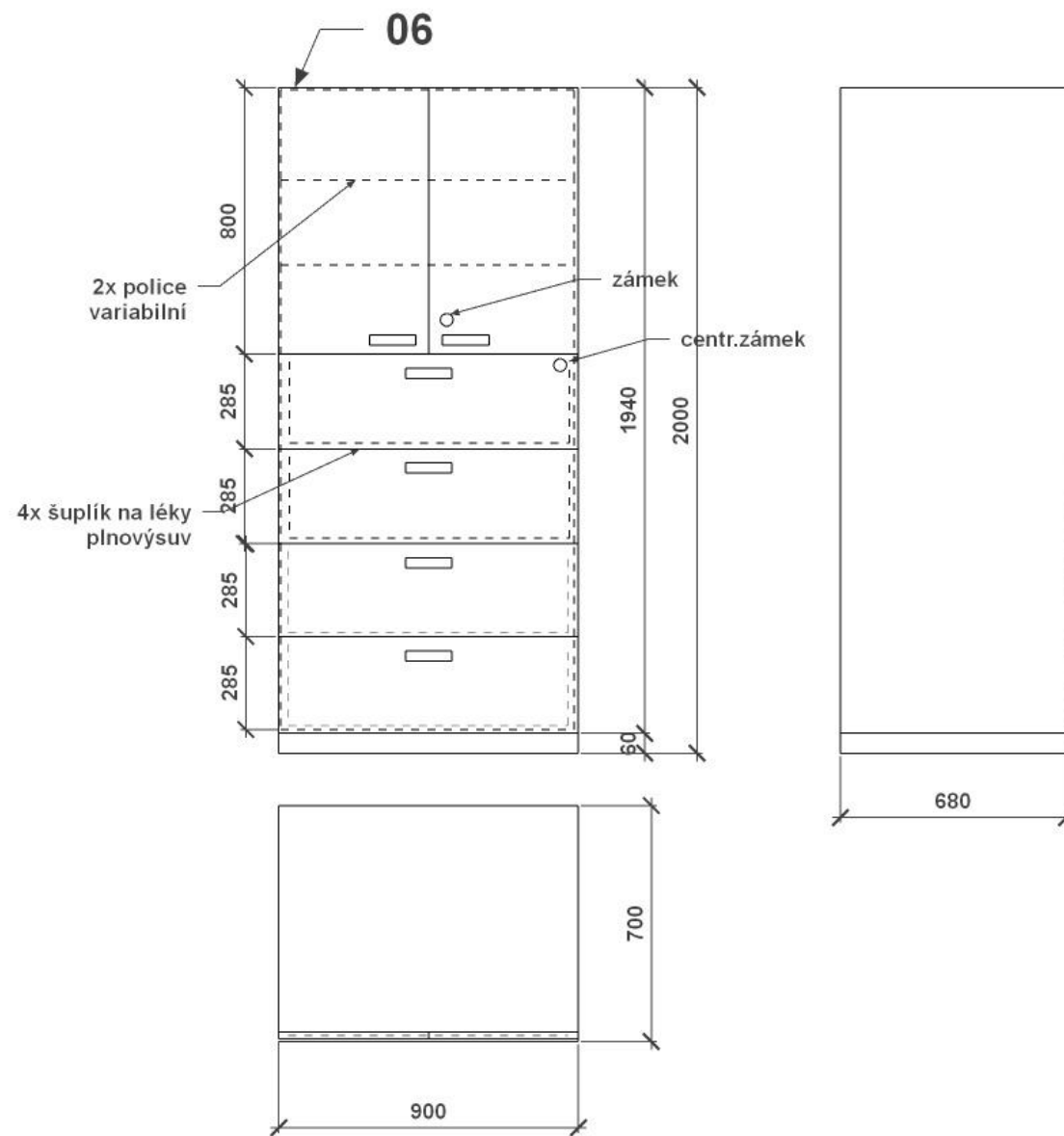

1KS místnost D204130

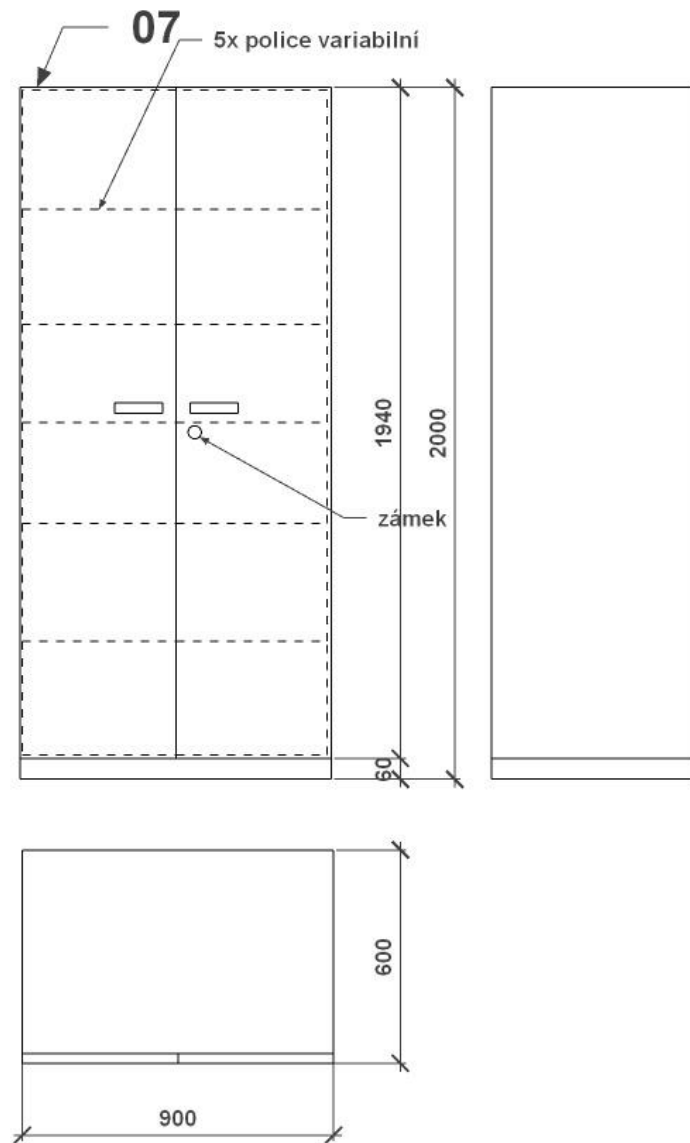

1KS místnost D204130

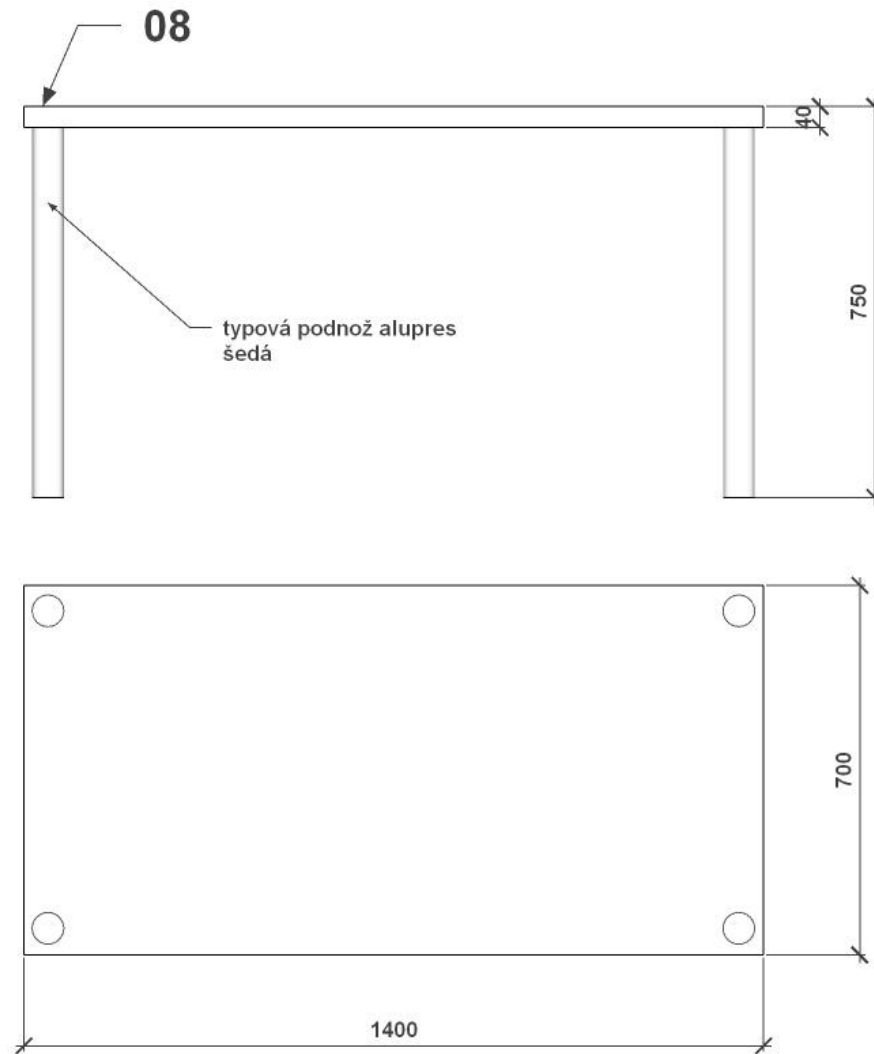

1KS místnost D204140

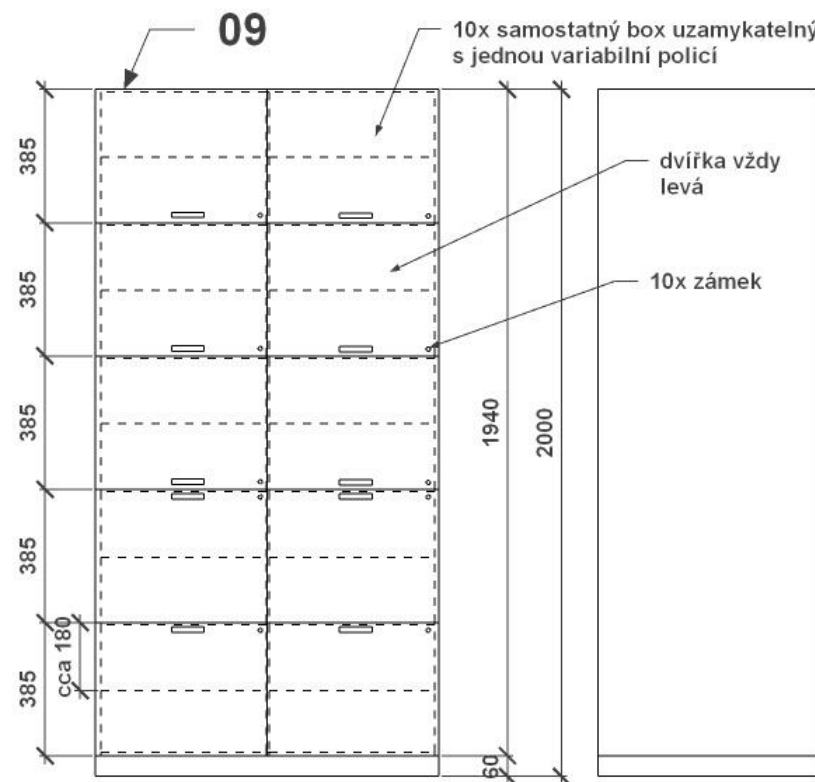

1KS místnost D204140

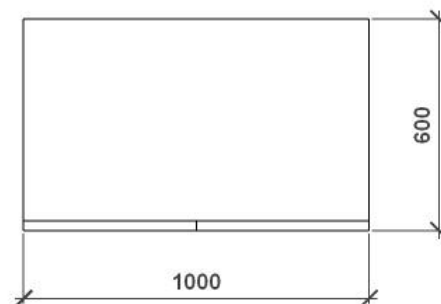

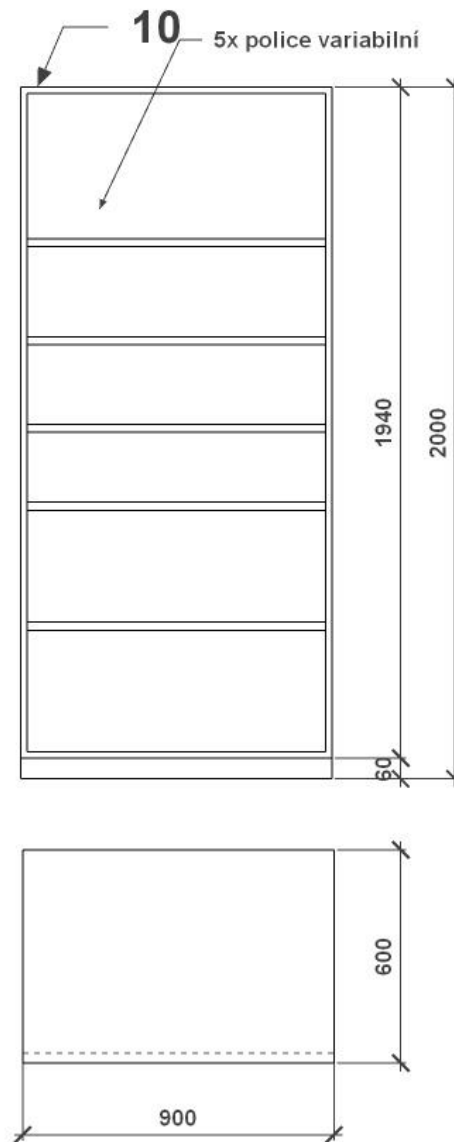

1KS místnost D204140 – vstupní filtr

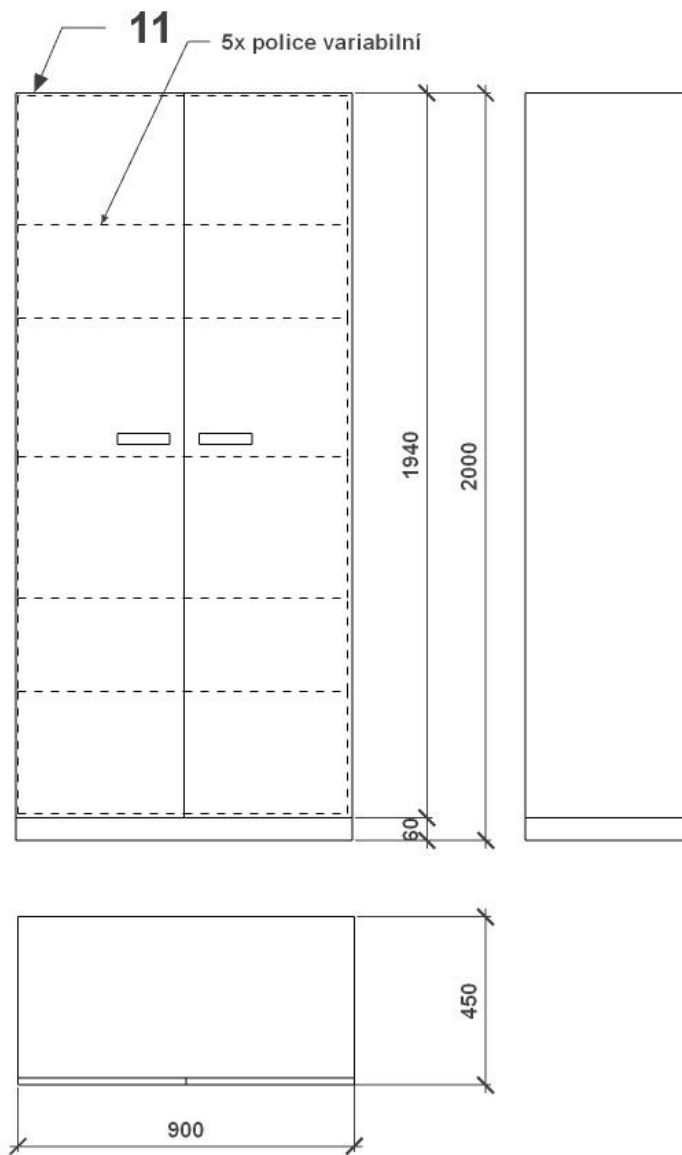

4KS místnost D204160

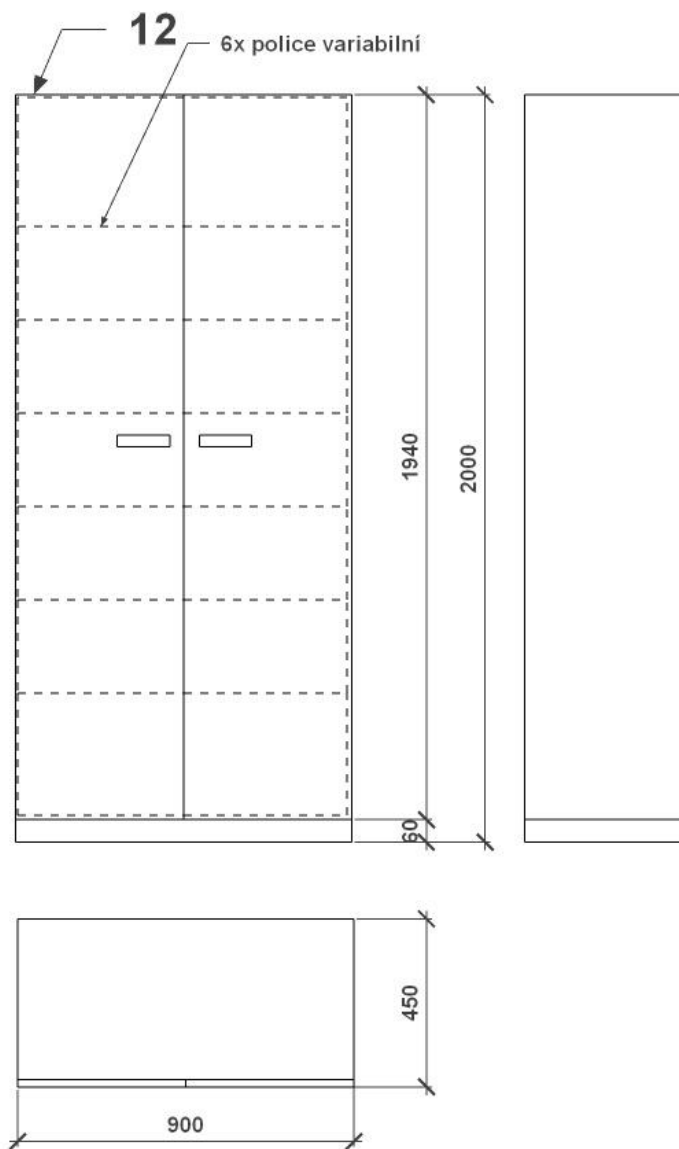

1KS místnost D204170



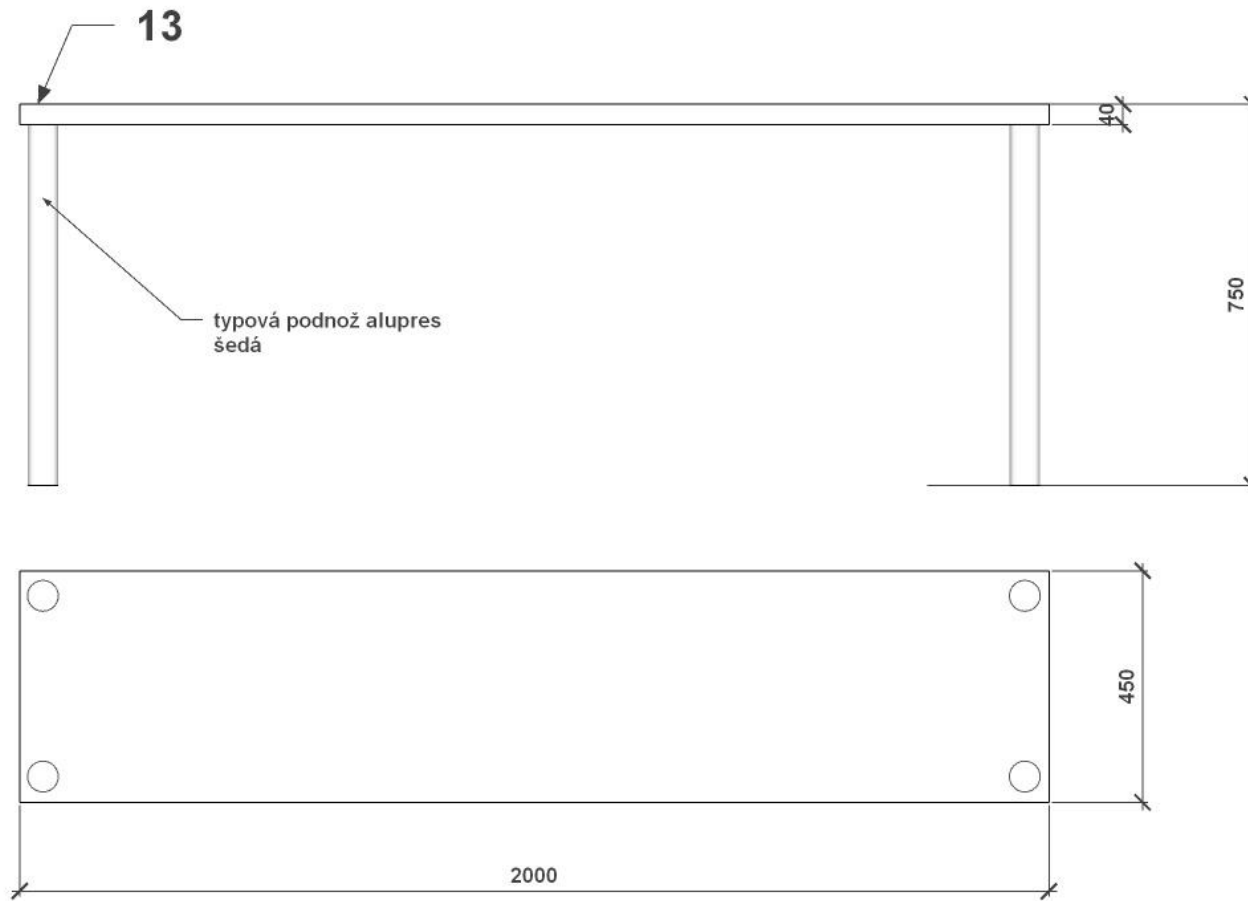

1KS místnost D204170

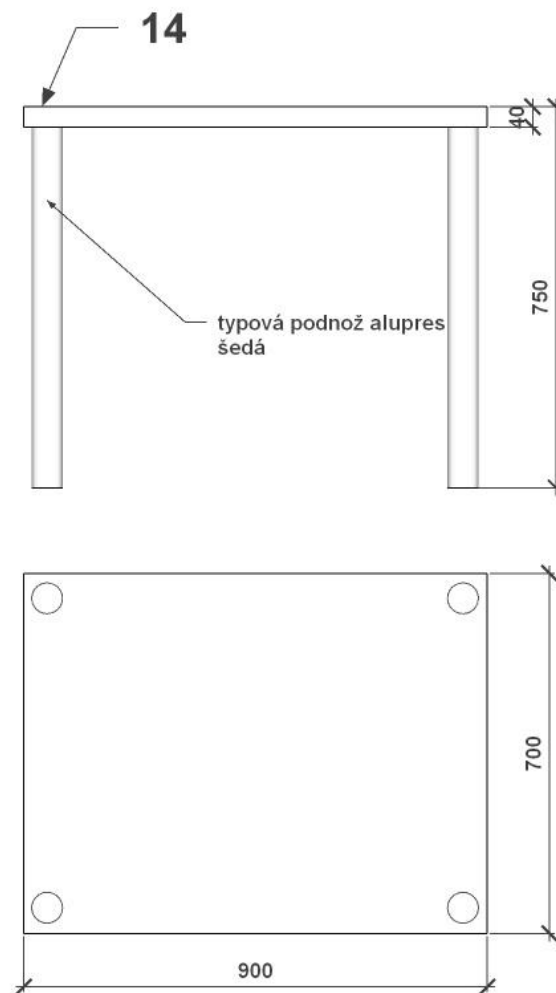

1KS místnost D204170

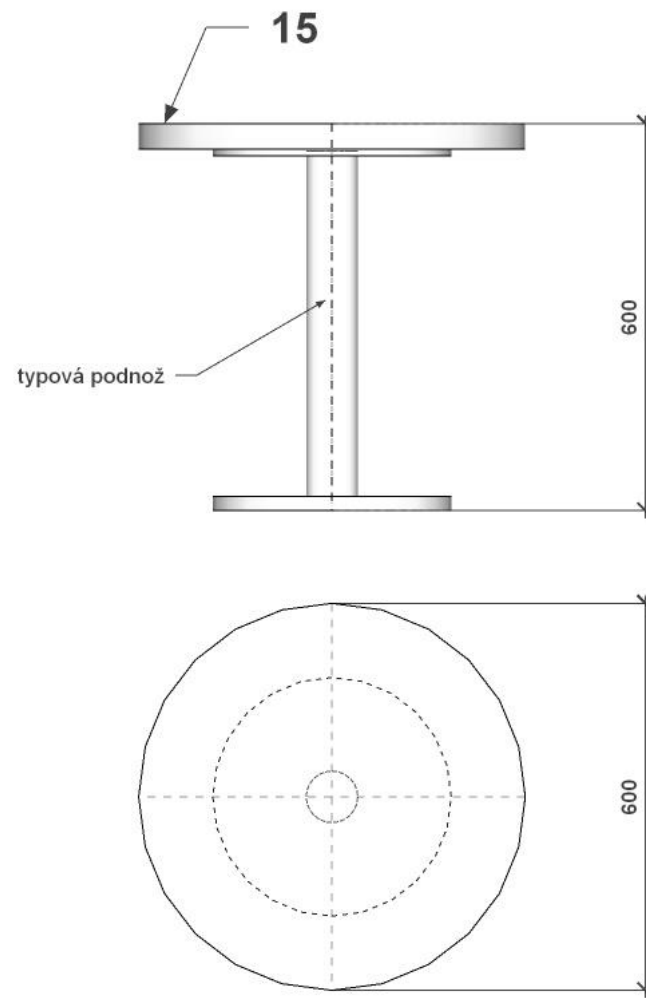

1KS místnost D204190  
1KS místnost D204210

2KS

STOLEK KONFERENCEČNÍ 15

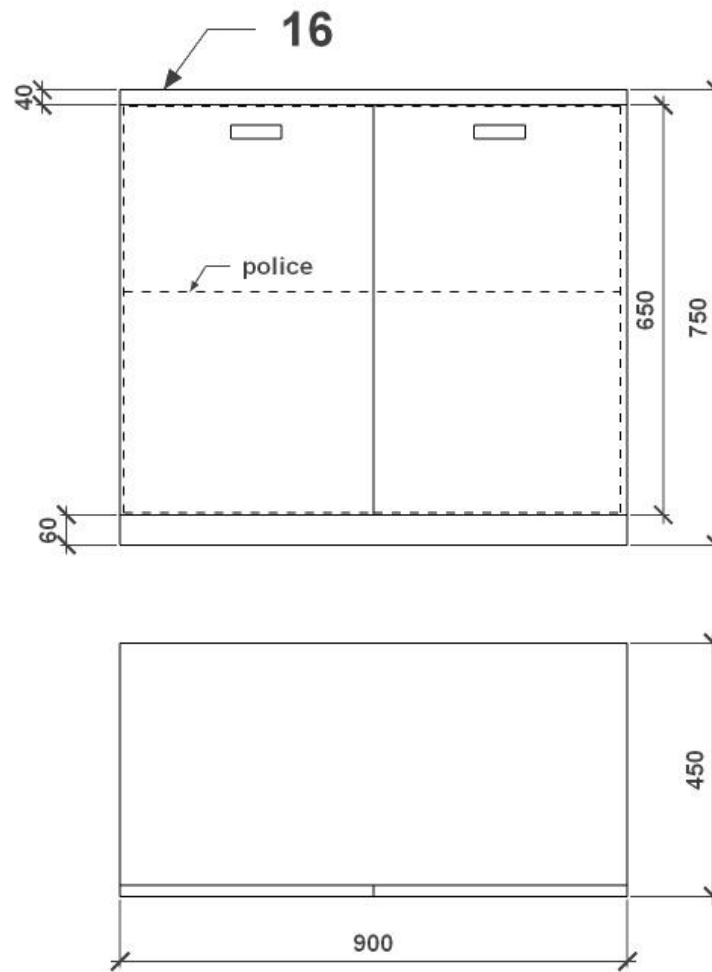

1KS místnost D204210

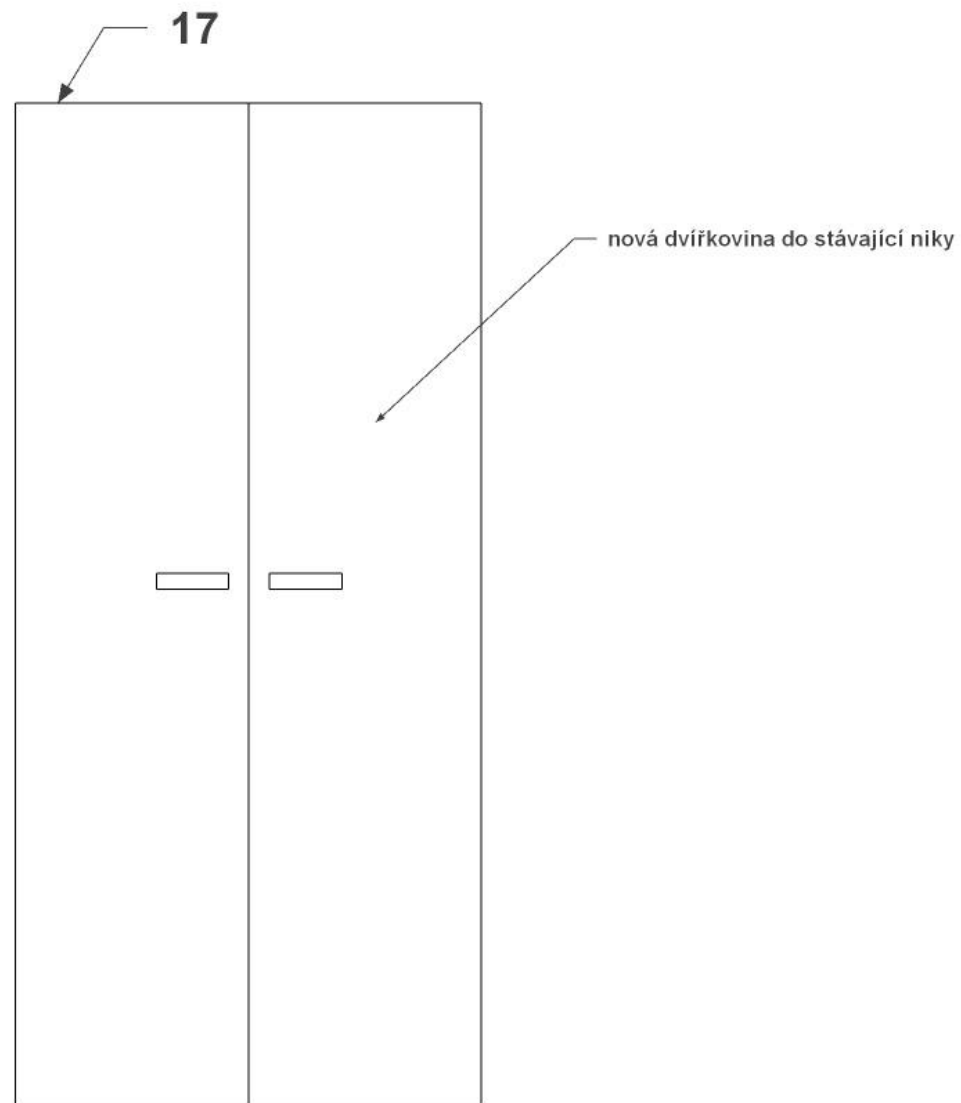

1KS místnost D204190  
1KS místnost D204210

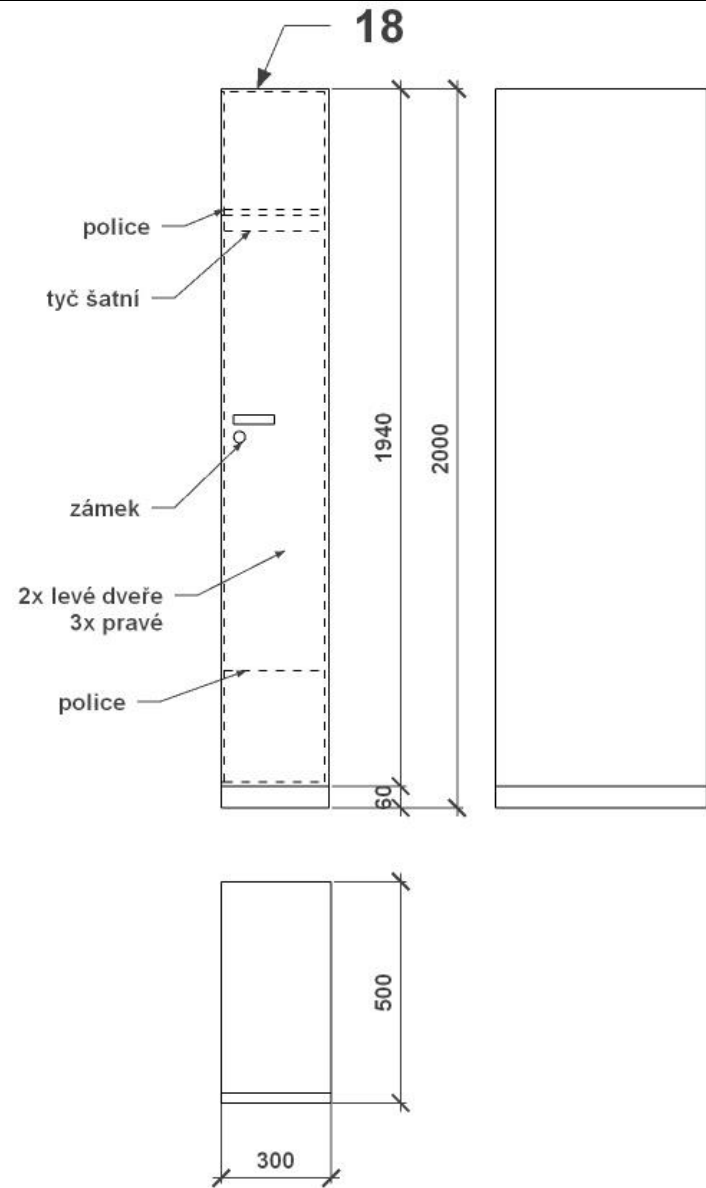

5KS místnost D204230

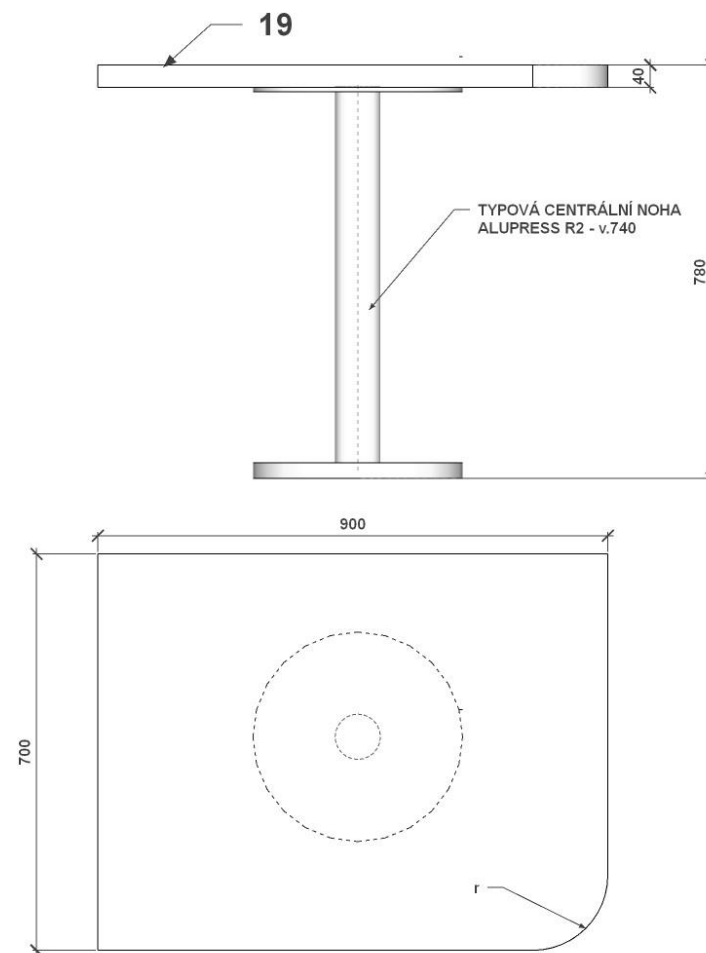

9KS POKOJE PACIENTŮ

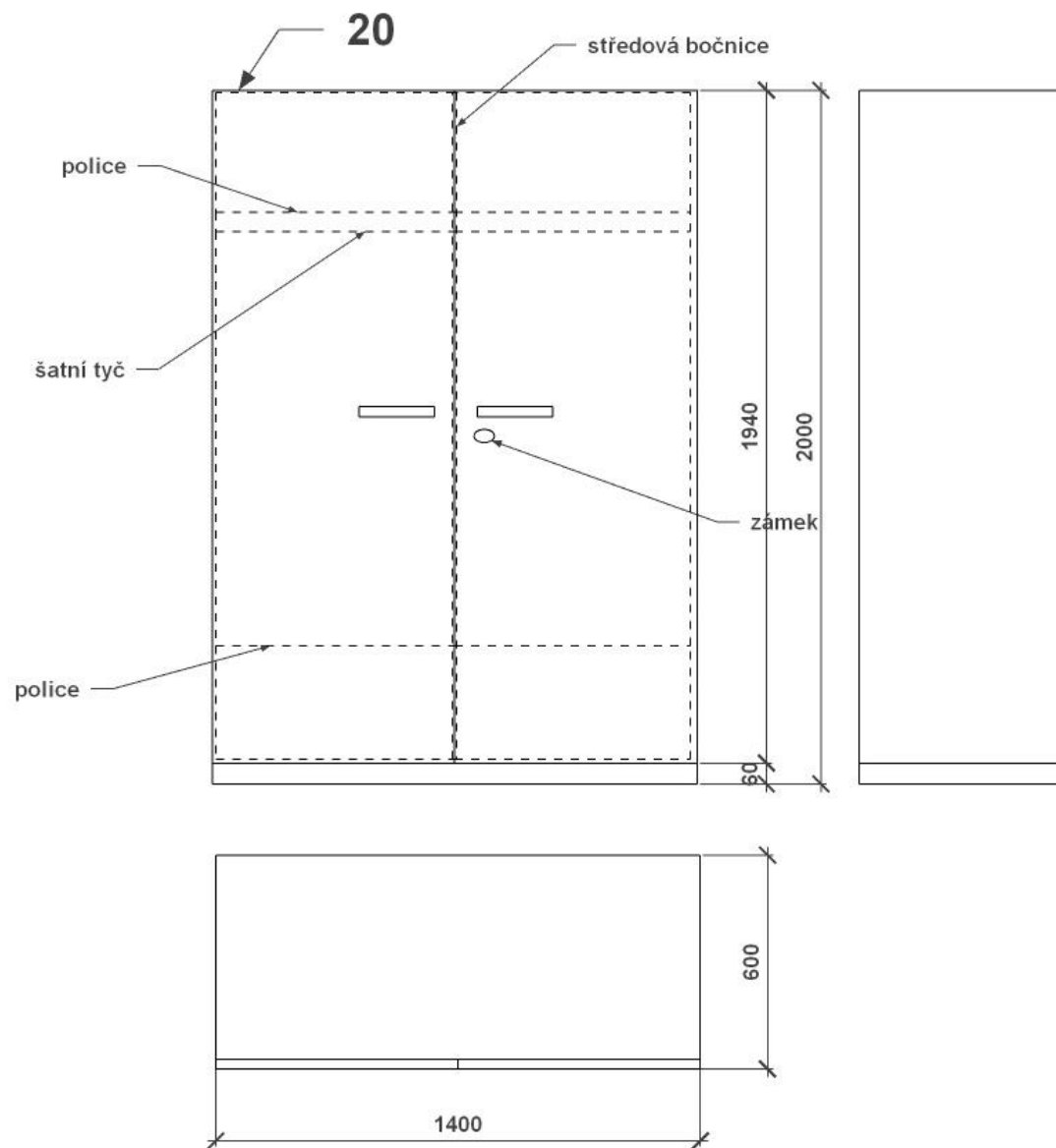

2KS místnost D204580





ZÁKLADNÍ NÁHLED

**EGGER : Taupe šedá - U750 ST9**

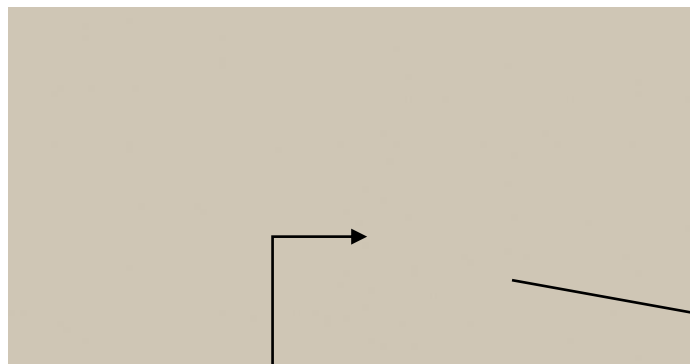

Použití :  
 • VŠE krom viz oblázkově šedá



**EGGER : Oblázkově šedá - U201 ST9**

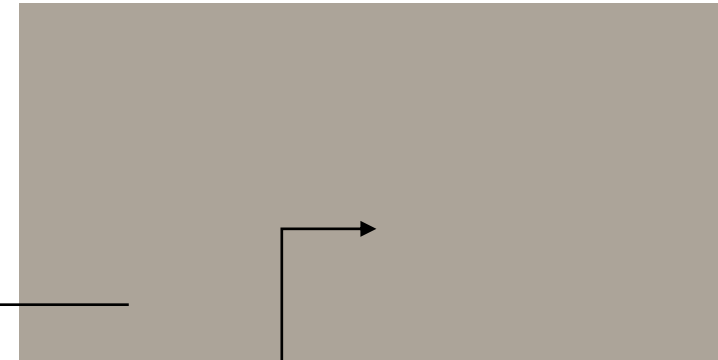

Použití :  
 • NÁSTĚNNÉ POLICE NAD PRACOVNÍMI STOLY  
 • DESKA KONFERENČNÍHO STOLKU – 2x  
 • VEŠKERÉ MOBILNÍ KONTEJNERY

**MATERIÁL:**

DTD/LTD omyvatelný materiál s ABS hranou tl.2mm na dvířkách a čelech korpusů a tl.0,5mm ostatních hran.  
 Desky tl.18mm, stolové pláty 36mm.  
 Pojezdy plnovýsuvy s dojezdem.

Alupress :Centrální stolová noha R2, satin, v.500 – konf.stolek, v.740 - pokoje



Stolová noha SN 710 , niklmat, v.710mm



Nábytková úchytka MARCA imitace nerez : HARV



Nábytkový věšák LINA velký nerez broušený : HARV

